

DİZAYN

GRUP

2023 EKİM

FİYAT LİSTESİ



// ELITEPIPE
"Güvenin ve Rahatlığın Keyfini Yaşa"



Web sitemizi ziyaret etmek için QR kodu okutunuz.

SEKTÖRE YÖN VEREN

ÜRÜNLERİMİZ

Türkiye'de ilk
PPR Boru Üretimi

Türkiye'de ilk
Orta Folyolu
PPR Boru Üretimi

Türkiye'de ilk
Deliksiz Alüminyum Folyolu
PPR Boru Üretimi

Türkiye'de ilk
Pex-B Boru Üretimi

Türkiye'de ilk
Oksijen Bariyerli Pex-B
Boru Üretimi

Türkiye'de ilk
PP Atıksu Boru ve Ek
Parçası Üretimi

Türkiye'de ilk
PE100 Temizsu Şebeke
Borusu Üretimi

Türkiye'de ilk
PE80 Doğalgaz Borusu
Üretimi

Türkiye'de ilk
Oksi Plus Kombi
Borusu Üretimi

Türkiye'de ilk
Jeotermal Bölgesel Isıtma
Borusu Üretimi



DIZAYN
GRUP



info@dizayngrup.com



www.dizayngrup.com

İÇİNDEKİLER

PPR TEMİZ SU SİSTEMLERİ

2



6

DUBTEK ATIK SU SİSTEMLERİ

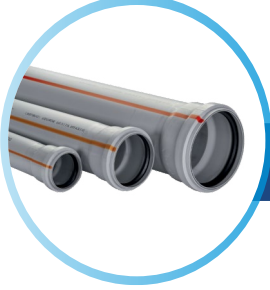

NANOTEK ATIK SU SİSTEMLERİ - SESSİZ

8



10

TRIPLEX ATIK SU SİSTEMLERİ - ÇOK SESSİZ

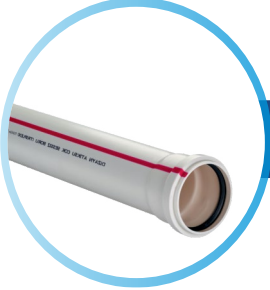

TRIPLEXTRA ATIK SU SİSTEMLERİ - YANMAZ SESSİZ

12



13

YAĞMUR OLUĞU VE EK PARÇALARI

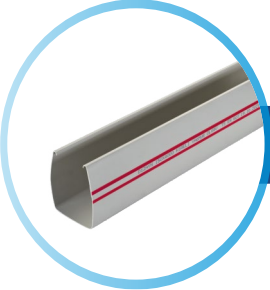

YUMUŞAK POLİETİLEN BORULARI - SOFT POWER

14

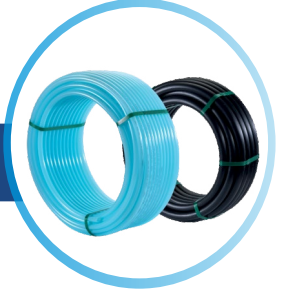

15

MOBİL BORU SİSTEMLERİ

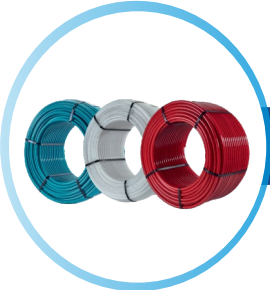

KARŞILAŞTIRMALI ÖZELLİKLER

17

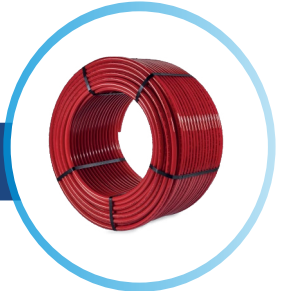

18

ELITE PIPE TESİSAT BORULARI

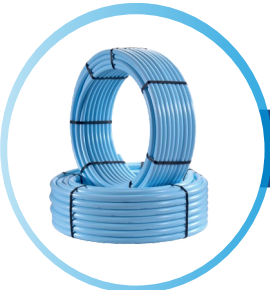

PPR BORU PN 20

KOD	ÇAP-ET mm	MİKTAR	FİYAT TL / m
30422	20 x 2,8	160	21,33
30424	25 x 3,5	120	32,95
30426	32 x 4,4	80	57,64
30428	40 x 5,5	60	100,77
30430	50 x 6,9	36	161,33
30432	63 x 8,6	24	254,25
30434	75 x 10,3	16	364,65
30436	90 x 12,3	12	578,98
30438	110 x 15,1	8	868,37
30440	125 x 17,1	4	1.281,65
50439	160x21,9	4	2.650,50
51038	200x27	4	4.717,39

PPR BORU PN 25

KOD	ÇAP-ET mm	MİKTAR	FİYAT TL / m
30302	20 x 3,4	160	26,67
30304	25 x 4,2	120	42,68
30306	32 x 5,4	80	76,80
30308	40 x 6,7	60	118,16
30310	50 x 8,3	36	189,24
30312	63 x 10,5	24	303,89
30314	75 x 12,5	16	458,92
30316	90 x 15,0	12	742,48
30318	110 x 18,4	8	1.058,10
30320	125 x 20,9	4	1.352,66
50440	160x26,6	4	3.252,00



HI-TECH PPR BORU PN 25

KOD	ÇAP-ET mm	MİKTAR	FİYAT TL / m
33302	20 x 3,4	160	28,27
33304	25 x 4,2	120	45,24
33306	32 x 5,4	80	81,40
33308	40 x 6,7	60	125,25
33310	50 x 8,3	36	200,60
33312	63 x 10,5	24	322,12

KOMPOZİT BORU PN 20 PLUS

KOD	ÇAP-ET mm	MİKTAR	FİYAT TL / m
33100	20 x 2,8	160	28,01
33102	25 x 3,5	120	43,16
33104	32 x 4,4	80	69,87
33106	40 x 5,5	60	110,23
33108	50 x 6,9	36	179,14
33110	63 x 8,6	24	274,13
33112	75 x 10,3	16	391,87
33114	90 x 12,3	12	601,52
33116	110 x 15,1	8	915,27

KOMPOZİT BORU PN 25 PLUS

KOD	ÇAP-ET mm	MİKTAR	FİYAT TL / m
33000	20 x 3,4	160	32,55
33002	25 x 4,2	120	47,96
33004	32 x 5,4	80	85,59
33006	40 x 6,7	60	127,82
33008	50 x 8,3	36	204,62
33010	63 x 10,5	24	326,94
33012	75 x 12,5	16	492,84
33014	90 x 15,0	12	790,49
33016	110 x 18,4	8	1.163,05

UV KATKILI PPR BORU PN 20

KOD	ÇAP-ET mm	MİKTAR	FİYAT TL / m
48645	20 x 2,8	160	32,70
48646	25 x 3,5	120	49,04
48647	32 x 4,4	80	80,75

KOMPOZİT BORU PN 20 EKO

KOD	ÇAP-ET mm	MİKTAR	FİYAT TL / m
33140	20 x 2,8	160	25,26
33142	25 x 3,5	120	38,91
33144	32 x 4,4	80	62,99
33146	40 x 5,5	60	99,38
33148	50 x 6,9	36	161,52
33150	63 x 8,6	24	247,14
33152	75 x 10,3	16	353,32
33154	90 x 12,3	12	542,33
33156	110 x 15,1	8	825,20

KOMPOZİT BORU PN 25 EKO

KOD	ÇAP-ET mm	MİKTAR	FİYAT TL / m
33160	20 x 2,8	160	29,34
33162	25 x 3,5	120	43,22
33164	32 x 4,4	80	77,16
33166	40 x 5,5	60	115,24
33168	50 x 6,9	36	184,49
33170	63 x 8,6	24	294,76
33172	75 x 10,3	16	444,35
33174	90 x 12,3	12	712,70
33176	110 x 15,1	8	1.048,60

UV KATKILI FOLYOLU BORU PN25

KOD	ÇAP-ET mm	MİKTAR	FİYAT TL / m
60366	20 x 3,4	160	56,37
60368	25 x 4,2	120	81,03
60370	32 x 5,4	80	165,18
60372	40 x 6,7	60	257,87
60374	50 x 8,3	36	382,08
60376	63 x 10,5	24	595,29



FOLYOLU BORU PN 25

KOD	ÇAP-ET mm	MİKTAR	FİYAT TL / m
33346	20 x 3,4	160	42,75
33348	25 x 4,2	120	58,08
33350	32 x 5,4	80	103,31
33352	40 x 6,7	60	158,04
33354	50 x 8,3	36	246,62
33356	63 x 10,5	24	395,61
33358	75 x 12,5	16	536,40
33359	90 x 15,0	12	914,39
33386	110 x 18,4	8	1.172,28



HI-TECH FOLYOLU BORU PN 32

KOD	ÇAP-ET mm	MİKTAR	FİYAT TL / m
33347	20 x 3,4	160	44,79
33349	25 x 4,2	120	66,62
33351	32 x 5,4	80	107,57
33353	40 x 6,7	60	170,95
33355	50 x 8,3	36	248,81
33357	63 x 10,5	24	558,19

DİZAYN PPR TEMİZ SU EK PARÇALARI

MANŞON



KOD	ÇAP mm	MİKTAR	FİYAT TL / ad.
33402	20	700/100	2,57
33404	25	500/100	3,78
33406	32	250/50	7,38
33408	40	120/15	12,39
33410	50	75/15	23,85
33412	63	48/6	41,48
30414	75	32/1	86,87
30416	90	20/1	202,00
30418	110	10/1	289,79
30420	125	9/1	367,38

DİRSEK 90°



KOD	ÇAP mm	MİKTAR	FİYAT TL / ad.
33602	20	500/100	3,33
33604	25	300/50	5,06
33606	32	150/25	10,28
33608	40	80/10	20,57
33610	50	45/5	38,78
33612	63	24/3	77,69
30614	75	12/1	133,57
30616	90	8/1	300,74
30618	110	4/1	500,82
30620	125	4/1	608,48

DİRSEK 45°



KOD	ÇAP mm	MİKTAR	FİYAT TL / ad.
33624	20	500/50	4,87
33626	25	400/50	5,96
33628	32	160/20	12,28
34525	40	80/20	35,16
34526	50	50/10	67,07
34527	63	30/5	86,94

REDÜKSİYON DİRSEK 90°



KOD	ÇAP mm	MİKTAR	FİYAT TL / ad.
31026	25-20	250/50	10,73
31027	32-25	150/50	17,35

KUYRUKLU DİRSEK 90°



KOD	ÇAP mm	MİKTAR	FİYAT TL / ad.
31023	20	300	6,95
31024	25	200	16,22

KUYRUKLU DİRSEK 45°



KOD	ÇAP mm	MİKTAR	FİYAT TL / ad.
31020	20	500	7,54
31021	25	200	14,95

TE



KOD	ÇAP mm	MİKTAR	FİYAT TL / ad.
33702	20	350/50	4,61
33704	25	200/50	6,65
33706	32	100/25	13,52
33708	40	60/10	28,52
33710	50	30/5	48,75
33712	63	16/2	109,98
30714	75	12/1	224,37
30716	90	6/1	474,40
30718	110	3/1	597,65
30720	125	2/1	652,37

İNEGAL TE



KOD	ÇAP mm	MİKTAR	FİYAT TL / ad.
33736	25-20-20	250/50	8,29
33738	25-20-25	200/25	8,61
33748	32-20-20	200/50	13,72
30754	32-20-25	150/25	14,66
33750	32-20-32	100/25	14,98
33754	32-25-20	150/25	14,38
33756	32-25-32	100/25	17,92
33728	40-20-40	60/10	26,72
33730	40-25-40	60/10	29,40
33732	40-32-40	60/10	31,29
33760	50-20-50	40/5	56,58
33762	50-25-50	30/5	58,86
33764	50-32-50	30/5	62,22
33766	50-40-50	30/5	71,95
33778	63-25-63	24/4	114,88
33772	63-32-63	16/2	94,52
33774	63-40-63	16/2	98,69
33776	63-50-63	16/2	101,76

REDÜKSİYON



KOD	ÇAP mm	MİKTAR	FİYAT TL / ad.
33504	25-20	600/50	2,92
33506	32-20	500/50	4,50
33508	32-25	360/40	5,16
33510	40-20	300/30	8,21
33512	40-25	250/25	8,79
33514	40-32	200/25	10,41
33516	50-20	200/25	13,43
33518	50-25	160/20	14,13
33520	50-32	150/25	15,19
33522	50-40	100/20	19,18
33524	63-25	125/25	23,69
33526	63-32	100/25	28,22
33528	63-40	80/20	30,10
33530	63-50	70/10	35,42
30532	75-50	50/10	103,31
30534	75-63	48/4	107,09
30536	90-63	35/5	113,64
30538	90-75	30/5	119,48
30540	110-90	18/1	228,67
30542	125-110	15/1	284,64



TE KAVİS



KOD	ÇAP mm	MİKTAR	FİYAT TL / ad.
33721	20	125/25	29,08
33722	25	80/10	40,79



MANŞONLU KAVİS



KOD	ÇAP mm	MİKTAR	FİYAT TL / ad.
34110	20	150/25	20,92
34112	25	80/20	29,01

DÜZ KAVİS



KOD	ÇAP mm	MİKTAR	FİYAT TL / ad.
30902	20	125/25	22,38
30904	25	60/15	32,18
30906	32	40/10	54,53

KÖRTAPA



KOD	ÇAP mm	MİKTAR	FİYAT TL / ad.
32100	20	2500/100	3,52
32102	25	2500/100	4,38

KAPAMA BAŞLIĞI



KOD	ÇAP mm	MİKTAR	FİYAT TL / ad.
33802	20	1400/100	3,43
33804	25	750/75	4,43
33806	32	400/50	8,14
33808	40	200/50	13,40
33810	50	125/25	21,28
33812	63	60/12	43,06
30814	75	40/5	115,01

TEKLİ KELEPÇE



KOD	ÇAP mm	MİKTAR	FİYAT TL / ad.
32212	20	2000/100	2,33
32214	25	2000/100	2,67
32216	32	1000/100	3,58
32217	40	750/50	8,74
32218	50	500/50	11,34

ÇİFTLİ KELEPÇE



KOD	ÇAP mm	MİKTAR	FİYAT TL / ad.
32228	20	2000/100	3,77
32230	25	1500/175	4,60
32232	32	1000/50	6,90

OMEGA



KOD	ÇAP mm	MİKTAR	FİYAT TL / ad.
30908	20	20/1	139,27
30910	25	12/1	202,82
30912	32	10/1	235,33

İSTAVROZ



KOD	ÇAP mm	MİKTAR	FİYAT TL / ad.
34000	20	300/50	11,48
34002	25	150/25	16,23
34004	32	90/15	27,73
34006	40	50/10	41,63

NİPEL İÇ DİŞLİ



KOD	ÇAP mm	MİKTAR ad.	FİYAT TL / ad
36202	20 1/2"	200/25	32,74
36204	20 3/4"	150/25	39,84
36206	25 3/4"	150/25	39,84
36208	25 1/2"	150/25	31,02
36210	32 1"	75/15	70,08

NİPEL DİŞ DİŞLİ



KOD	ÇAP mm	MİKTAR ad.	FİYAT TL / ad
36402	20 1/2"	150/25	34,47
36404	20 3/4"	150/25	50,00
36406	25 3/4"	100/25	48,83
36408	25 1/2"	150/25	34,68
36410	32 1"	50/10	84,70

RAKORLU DİRSEK



KOD	ÇAP mm	MİKTAR ad.	FİYAT TL / ad
34430	20 1/2"	100/25	94,74
34432	25 3/4"	75/15	113,56

ALTI KÖŞE NİPEL İÇ DİŞLİ



KOD	ÇAP mm	MİKTAR ad.	FİYAT TL / ad
36211	32 1"	50/5	77,37
36212	40 1 1/4"	32/8	149,49
36214	50 1 1/2"	20/2	188,03
36216	63 2"	16/1	381,57
31218	75 2 1/2"	7/1	764,23
31220	90 3"	6/1	1.175,59
31222	110 4"	3/1	1.810,25
31224	125 5"	2/1	3.544,99

ALTI KÖŞE NİPEL DİŞ DİŞLİ



KOD	ÇAP mm	MİKTAR ad.	FİYAT TL / ad
36411	32 1"	50/10	110,26
36412	40 1 1/4"	30/5	191,35
36414	50 1 1/2"	20/4	248,19
36416	63 2"	12/1	378,33
31418	75 2 1/2"	6/1	986,22
31420	90 3"	5/1	1.511,47
31422	110 4"	3/1	2.290,05
31424	125 5"	2/1	5.034,19

RAKORLU NİPEL



KOD	ÇAP mm	MİKTAR ad.	FİYAT TL / ad
34426	20 1/2"	150/25	90,57
34428	25 3/4"	125/25	113,56

O.B. ALTI KÖŞE RAKOR İÇ DİŞLİ



KOD	ÇAP mm	MİKTAR ad.	FİYAT TL / ad
31302	20 1/2"	100/25	62,70
31304	25 3/4"	50/10	99,46
31306	32 1"	50/10	121,15
31310	20 1"	50/10	140,08
31312	25 1"	50/10	153,16
31314	40 1 1/4"	25/5	214,05
31316	50 1 1/2"	20/5	386,62

O.B. ALTI KÖŞE RAKOR DİŞ DİŞLİ



KOD	ÇAP mm	MİKTAR ad.	FİYAT TL / ad
31502	20 1/2"	100/25	65,58
31504	25 3/4"	50/10	97,24
31508	32 1"	40/10	128,24
31512	20 1"	40/10	139,60
31514	25 1"	40/10	142,60
31516	40 1 1/4"	25/5	231,07
31518	50 1 1/2"	20/5	407,98

İKİ TARAFI KAYNAKLI RAKOR



KOD	ÇAP mm	MİKTAR ad.	FİYAT TL / ad
31520	20	80	118,97
31521	25	50	160,66
31522	32	40	183,11
31523	40	25	343,70
31524	50	15	398,41

DİRSEK İÇ DİŞLİ



KOD	ÇAP mm	MİKTAR ad.	FİYAT TL / ad
36602	20 1/2"	125/25	33,27
36604	20 3/4"	100/25	41,15
36606	25 1/2"	125/25	37,82
36608	25 3/4"	75/25	42,20
36610	32 3/4"	50/10	55,66
36612	32 1"	50/10	78,55

DİRSEK DİŞ DİŞLİ



KOD	ÇAP mm	MİKTAR ad.	FİYAT TL / ad
36616	20 1/2"	125/25	37,70
36618	20 3/4"	100/25	49,87
36620	25 1/2"	100/25	42,44
36622	25 3/4"	75/15	49,87
36624	32 3/4"	50/10	64,30
36626	32 1"	50/10	91,87

PİSLİK TUTUCU



KOD	ÇAP mm	MİKTAR ad.	FİYAT TL / ad
34434	20	50/25	97,26
34436	25	50/25	111,60

TE İÇ DİŞLİ



KOD	ÇAP mm	MİKTAR ad.	FİYAT TL / ad
36702	20 1/2"	125/25	34,24
36704	20 3/4"	100/25	44,69
36706	25 1/2"	80/20	39,45
36708	25 3/4"	80/20	45,49
36710	32 3/4"	50/10	72,69
36712	32 1"	50/10	83,58

TE DİŞ DİŞLİ



KOD	ÇAP mm	MİKTAR ad.	FİYAT TL / ad
36716	20 1/2"	125/25	39,19

ÇEKVALF



KOD	ÇAP mm	MİKTAR ad.	FİYAT TL / ad
34900	20	50	117,28
34902	25	50	134,46

TEKLİ BATARYA BAĞ. İÇ DİŞLİ



KOD	ÇAP mm	MİKTAR ad.	FİYAT TL / ad
36102	20 1/2"	100/25	37,04
31104	25 1/2"	75/15	47,84

ÇİFTLİ BATARYA BAĞ. İÇ DİŞLİ



KOD	ÇAP mm	MİKTAR ad.	FİYAT TL / ad
31114	20 1/2"	20/2	90,29
31116	25 1/2"	20/2	116,93

TAHARET BATARYA BAĞ. İÇ DİŞLİ



KOD	ÇAP mm	MİKTAR ad.	FİYAT TL / ad
36101	20 1/2"	28/4	91,94

HI-TECH NİPEL İÇ DİŞLİ



KOD	ÇAP mm	MİKTAR ad.	FİYAT TL / ad
34202	20 1/2"	200/25	34,37
34204	20 3/4"	150/25	41,83
34206	25 3/4"	150/25	41,83
34208	25 1/2"	150/25	32,58
34210	32 1"	75/15	73,58

HI-TECH ALTI KÖŞE NİPEL İÇ DİŞLİ



KOD	ÇAP mm	MİKTAR ad.	FİYAT TL / ad
34211	32 1"	50	81,24
34212	40 1 1/4"	32	156,96
34214	50 1 1/2"	20	197,44
34216	63 2"	16	400,65

HI-TECH DİRSEK İÇ DİŞLİ



KOD	ÇAP mm	MİKTAR ad.	FİYAT TL / ad
34602	20 1/2"	125/25	34,93
34604	20 3/4"	100/25	43,21
34606	25 1/2"	125/25	39,71
34608	25 3/4"	75/25	44,31
34610	32 3/4"	50/10	58,44
34612	32 1"	50/10	82,48

DÜNYADA TEK



SMART KÜRESEL VANA - Mavi

KOD	ÇAP mm	MİKTAR ad.	FİYAT TL / ad
35758	20	60	101,30
35760	25	40	124,61
35762	32	20	181,20

DÜNYADA TEK



SMART KÜRESEL VANA - Kırmızı

KOD	ÇAP mm	MİKTAR ad.	FİYAT TL / ad
35766	20	60	101,30
35768	25	40	124,61
35770	32	20	181,20

SMART VANA SETİ



KOD	ÇAP mm	MİKTAR ad.	FİYAT TL / ad
1120	20	10	1.003,00
1122	25	10	1.234,00
1124	32	7	1.256,00

ÖZEL KAYNAK PAFTASI



KOD	ÇAP mm	MİKTAR ad.	FİYAT TL / ad
46630	20	50	191,23
46631	25	50	208,76
46632	32	25	242,41
46633	40	20	268,61
46634	50	10	407,71
46635	63	5	574,92
46636	75	4	843,75
46646	90	2	1.227,66
47824	110	2	1.457,17
43162	125	1	1.832,85

HI-TECH NİPEL DİŞ DİŞLİ



KOD	ÇAP mm	MİKTAR ad.	FİYAT TL / ad
34402	20 1/2"	150/25	36,19
34404	20 3/4"	150/25	52,50
34406	25 3/4"	100/20	51,27
34408	25 1/2"	150/25	36,41
34410	32 1"	50/10	88,93

HI-TECH ALTI KÖŞE NİPEL DİŞ DİŞLİ



KOD	ÇAP mm	MİKTAR ad.	FİYAT TL / ad
34411	32 1"	50	115,77
34412	40 1 1/4"	32	200,91
34414	50 1 1/2"	20	260,60
34416	63 2"	16	397,25

HI-TECH DİRSEK DİŞ DİŞLİ



KOD	ÇAP mm	MİKTAR ad.	FİYAT TL / ad
34616	20 1/2"	125/25	39,58
34618	20 3/4"	100/25	52,36
34620	25 1/2"	100/25	44,57
34622	25 3/4"	75/25	52,36
34624	32 3/4"	50/10	67,52
34626	32 1"	50/10	96,46

PİRİNÇ GÖBEKLİ KÜRESEL VANA



KOD	ÇAP mm	MİKTAR ad.	FİYAT TL / ad
34836	20	60	138,54
34838	25	40	164,70
34840	32	20	253,35
34842	40	15	331,60

PİRİNÇ GÖBEKLİ KÜRESEL VANA



KOD	ÇAP mm	MİKTAR ad.	FİYAT TL / ad
34826	20	60	141,78
34828	25	40	169,44
34830	32	20	258,20
34832	40	15	345,87

KAYNAK MAKİNASI SET



KOD	ÇAP mm	MİKTAR ad.	FİYAT TL / ad
43144	20-40	2	3.439,76

KAYNAK MAKİNASI TEKLİ



KOD	ÇAP mm	MİKTAR ad.	FİYAT TL / ad
43145	20-40	6	2.327,12

KOMBİ BAĞLANTI SETİ



KOD	MİKTAR ad.	FİYAT TL / ad
965	8'li nipelli	1 975,61
964	8'li dirsekli	1 975,61

HI-TECH TEKLİ BAT. BAĞ. İÇ DİŞLİ



KOD	ÇAP mm	MİKTAR ad.	FİYAT TL / ad
34102	20 1/2"	100	38,90

HI-TECH TE DİŞ DİŞLİ



KOD	ÇAP mm	MİKTAR ad.	FİYAT TL / ad
34716	20 1/2"	125/25	41,15

HI-TECH TE İÇ DİŞLİ



KOD	ÇAP mm	MİKTAR ad.	FİYAT TL / ad
34702	20 1/2"	125/25	35,95
34704	20 3/4"	100/25	46,92
34706	25 1/2"	80/20	41,42
34708	25 3/4"	80/25	47,77
34710	32 3/4"	50/10	76,32
34712	32 1"	50/10	87,76

KROMLU VANA



KOD	ÇAP mm	MİKTAR ad.	FİYAT TL / ad
34804	20	40	256,65
34806	25	30	282,43

KROMLU UZUN VANA



KOD	ÇAP mm	MİKTAR ad.	FİYAT TL / ad
34805	20	25	317,64
34807	25	25	346,07

KELEBEK BAŞLI VANA



KOD	ÇAP mm	MİKTAR ad.	FİYAT TL / ad
34800	20	40	142,21
34802	25	30	152,10
34803	32	20	246,25

BATARYA BAĞLANTI KÖRTAPASI



KOD	ÇAP mm	MİKTAR ad.	FİYAT TL / ad
411	20		29,90

BORU MAKASI



KOD	ÇAP mm	MİKTAR ad.	FİYAT TL / ad
43146	20-40	5	640,54

ALIN DÜZELTME APARATI



KOD	ÇAP mm	MİKTAR ad.	FİYAT TL / ad
46626	20-50	30	65,93
46627	32-40	15	81,66
46628	50-63	6	739,50
46629	75-90	2	770,22
47822	110	2	1.519,03

*Oksi Plus kombi borusu için

DUBTEK ATIK SU BORULARI

KOD	ÇAP - BOY mm	ET mm	MİKTAR ad.	FİYAT TL / ad.
8200	50 - 150	2,1	156	19,18
8201	50 - 250	2,1	104	25,64
8202	50 - 500	2,1	52	35,52
8203	50 - 1000	2,1	26	62,07
8204	50 - 2000	2,1	26	118,69
8205	50 - 3000	2,1	26	180,46
8206	50 - 6000	2,1	102	360,92
8207	70 - 150	2,4	26	31,52
8208	70 - 250	2,4	68	41,99
8209	70 - 500	2,4	34	58,82
8210	70 - 1000	2,4	17	109,23
8211	70 - 2000	2,4	17	202,94
8212	70 - 3000	2,4	17	296,85
8213	70 - 6000	2,4	17	593,70
8214	110 - 150	3,2	42	45,56
8215	110 - 250	3,2	28	63,75
8216	110 - 500	3,2	14	86,57
8217	110 - 1000	3,2	7	148,06
8218	110 - 2000	3,2	7	313,61
8219	110 - 3000	3,2	7	434,69
8220	110 - 6000	3,2	7	912,85
8221	125 - 150	3,2	42	58,33
8222	125 - 250	3,2	28	78,74
8223	125 - 500	3,2	14	119,39
8224	125 - 1000	3,2	7	226,90
8225	125 - 2000	3,2	7	441,90
8226	125 - 3000	3,2	7	659,38
8227	125 - 6000	3,2	7	1.318,76
8228	160 - 150	3,6	30	86,98
8229	160 - 250	3,6	20	122,07
8230	160 - 500	3,6	10	179,45
8231	160 - 1000	3,6	5	311,68
8232	160 - 2000	3,6	5	647,52
8233	160 - 3000	3,6	5	929,04
8234	160 - 6000	3,6	5	1.858,09



İÇ KATMAN

Üstün akış performansı ve kamera izlenebilirliği sağlayan açık renkli ve anti-bakteriyel PP iç katman

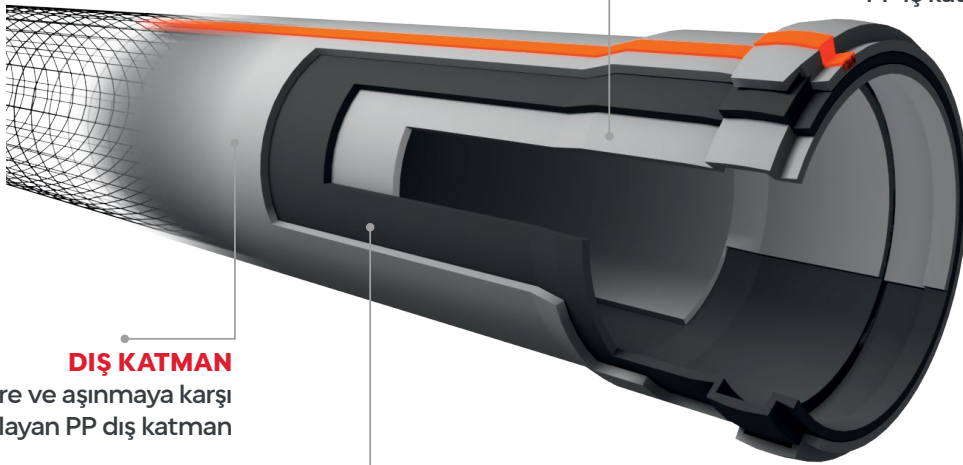

DIŞ KATMAN

Darbelere ve aşınmaya karşı dayanım sağlayan PP dış katman

ORTA KATMAN

Sessizliği ve yük dayanımı için AR-GE çalışmaları sonucu özel olarak geliştirilmiş PP - MD orta katman

DİZAYN DUBTEK ATIK SU EK PARÇALARI

DİRSEK 45°



KOD	ÇAP mm	MİKTAR ad.	FİYAT TL / m
8035	50	100	11,56
8036	70	40	30,90
8037	110	10	47,97
8038	125	10	78,05
8044	160	5	142,87

DİRSEK 87°



KOD	ÇAP mm	PAKET ad.	FİYAT TL / m
8039	50	75	16,23
8040	70	30	31,73
8041	110	10	59,76
8042	125	8	113,99
8043	160	4	174,79

TEMİZLEME TE 90°



KOD	ÇAP mm	PAKET ad.	FİYAT TL / m
8097	70	20	71,16
8098	110	8	131,86
8099	125	6	233,49
8100	160	3	331,44

TEK ÇATAL 45°



KOD	ÇAP mm	MİKTAR ad.	FİYAT TL / m
8045	50-50	40	31,82
8046	70-50	20	35,89
8047	70-70	15	70,08
8048	110-50	8	74,72
8049	110-70	8	99,27
8050	110-110	4	124,61
8051	125-50	4	154,46
8052	125-70	4	166,33
8053	125-100	4	191,38
8054	125-125	4	234,00
8055	160-50	2	194,62
8056	160-70	2	211,64
8057	160-110	3	244,53
8058	160-125	3	280,41
8059	160-160	2	364,83

ÇİFT ÇATAL 45°



KOD	ÇAP mm	MİKTAR ad.	FİYAT TL / m
8075	50-50	30	38,04
8076	70-50	15	52,15
8077	70-70	10	82,06
8078	110-50	9	81,68
8079	110-70	6	124,75
8080	110-110	3	133,09
8081	125-50	5	131,93
8082	125-70	4	157,47
8083	125-100	3	192,45
8084	125-125	2	256,56
8085	160-50	2	296,95
8086	160-70	2	321,03
8087	160-110	2	311,45
8088	160-125	2	365,82
8089	160-160	1	509,99

TE ÇATAL 90°



KOD	ÇAP mm	PAKET ad.	FİYAT TL / m
8060	50-50	50	28,79
8061	70-50	20	43,71
8062	70-70	20	54,57
8063	110-50	12	65,46
8064	110-70	9	88,92
8065	110-110	8	93,79
8066	125-50	10	158,79
8067	125-70	8	169,07
8068	125-100	6	181,97
8069	125-125	6	210,88
8070	160-50	4	254,95
8071	160-70	4	281,33
8072	160-110	4	291,51
8073	160-125	3	326,87

REDÜKSİYON



KOD	ÇAP mm	MİKTAR ad.	FİYAT TL / m
8090	70-50	60	23,47
8091	110-50	25	35,25
8092	110-70	25	40,50
8093	125-70	15	59,49
8094	125-110	15	75,90
8095	160-110	12	125,71
8096	160-125	12	121,97

MANŞON



KOD	ÇAP mm	PAKET ad.	FİYAT TL / m
8127	50	60	22,07
8128	70	40	34,31
8129	110	15	63,94

KÖRTAPA



KOD	ÇAP mm	PAKET ad.	FİYAT TL / m
8108	50	500	7,44
8109	70	200	15,11
8110	110	75	28,10
8111	125	60	32,82

W SİFON



KOD	ÇAP mm	PAKET ad.	FİYAT TL / m
8122	110		253,00

S SİFON 87°



KOD	ÇAP mm	PAKET ad.	FİYAT TL / m
8101	110	4	173,34

S SİFON 45°



KOD	ÇAP mm	PAKET ad.	FİYAT TL / m
8125	110	4	183,97

PLASTİK KELEPÇE



KOD	ÇAP mm	PAKET ad.	FİYAT TL / m
2102	50	200	7,85
2103	70	200	13,86
2104	110	100	22,00
2105	125	100	40,68
2106	160	50	77,86

SOMUNLU KELEPÇE



KOD	ÇAP mm	PAKET ad.	FİYAT TL / m
4102	50	150	19,93
4103	70	100	42,18
4104	110	75	56,64
4105	125	75	71,50
4106	160	40	86,37

TRİFONLU KELEPÇE



KOD	ÇAP mm	PAKET ad.	FİYAT TL / m
4523	50	100	21,69
4524	70	75	42,58
4526	110	35	61,19
4528	125	35	73,91
4530	160	25	92,39

NANOTEK ATIK SU BORULARI

KOD	ÇAP-BOY mm	ET mm	MİKTAR	FİYAT TL/ad.
5200	50 - 150	2,2	156	21,74
5201	50 - 250	2,2	104	29,07
5202	50 - 500	2,2	52	40,29
5203	50 - 1000	2,2	26	70,39
5204	50 - 2000	2,2	26	134,57
5205	50 - 3000	2,2	26	204,63
5206	50 - 6000	2,2	26	409,26
5207	70 - 150	2,5	102	35,75
5208	70 - 250	2,5	68	47,61
5209	70 - 500	2,5	34	66,70
5210	70 - 1000	2,5	17	123,85
5211	70 - 2000	2,5	17	230,11
5212	70 - 3000	2,5	17	336,59
5213	70 - 6000	2,5	17	673,18
5214	110 - 150	3,4	42	51,67
5215	110 - 250	3,4	28	72,28
5216	110 - 500	3,4	14	103,06
5217	110 - 1000	3,4	7	176,28
5218	110 - 2000	3,4	7	355,61
5219	110 - 3000	3,4	7	517,53
5220	110 - 6000	3,4	7	1.035,05
5221	125 - 150	3,5	42	66,14
5222	125 - 250	3,5	28	89,28
5223	125 - 500	3,5	14	135,38
5224	125 - 1000	3,5	7	257,29
5225	125 - 2000	3,5	7	501,09
5226	125 - 3000	3,5	7	747,67
5227	125 - 6000	3,5	7	1.495,33
5228	160 - 150	4,0	30	98,62
5229	160 - 250	4,0	20	138,42
5230	160 - 500	4,0	10	203,47
5231	160 - 1000	4,0	5	353,41
5232	160 - 2000	4,0	5	734,20
5233	160 - 3000	4,0	5	1.053,44
5234	160 - 6000	4,0	5	2.106,87



DEBİ Litre/saniye	0,5	1	2	4
EN 14366	<10	<10	13	18
DIN 4109	<10	11	15	20
VDI 4100	<10	<10	12	17

Sessizlik değerleri dB (A) cinsindedir.

Dizayn **Nanotek** Sessiz Atık Su Sistemi; boru, ek parça ve sessizlik kelepçesi ile bütündür. FRAUNHOFER Yapı Fiziği Enstitüsü IBP tarafından P-BA 245 /2019 e numaralı raporuyla ŞEKİL.2'deki test düzeneği ile sırasıyla, saniyede 0,5 - 1 - 2 ve 4 litrelik akışlarla ölçülmüştür.



AKIŞ KOLAYLIĞI
SAĞLAR



DAHA GÜÇLÜ
DAHA SESSİZ

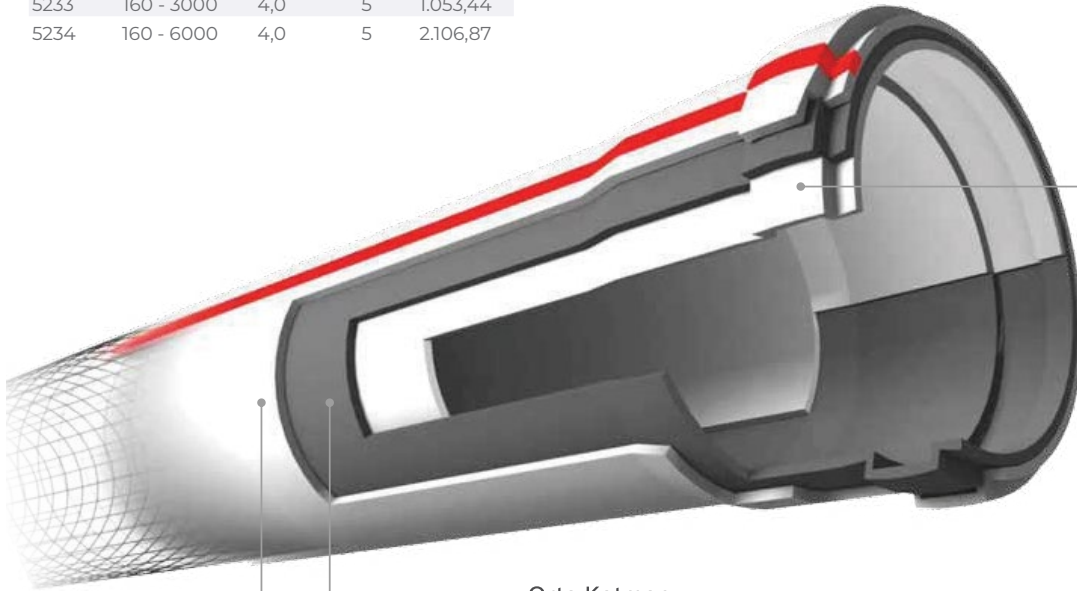

Dış Katman

Darbeler ve aşınmaya karşı dayanım sağlayan PP dış katman

Orta Katman

Sessizlik ve yük dayanımı için Ar-ge çalışmaları sonucu özel olarak geliştirilmiş PP - MD Orta katman

İç Katman

Üstün akış performansı ve kamera izlenebilirliği sağlayan açık renkli ve anti-bakteriyel PP iç katman



DİRSEK 45°



KOD	ÇAP mm	MİKTAR ad.	FİYAT TL / m
2035	50	100	13,14
2036	70	40	35,11
2037	110	10	54,52
2038	125	10	88,70
2044	160	5	162,35

DİRSEK 87°



KOD	ÇAP mm	PAKET ad.	FİYAT TL / m
2039	50	75	18,44
2040	70	30	36,06
2041	110	10	67,91
2042	125	8	129,53
2043	160	4	198,62

TEMİZLEME TE 90°



KOD	ÇAP mm	PAKET ad.	FİYAT TL / m
2097	70	20	80,87
2098	110	8	149,84
2099	125	6	265,32
2100	160	3	376,64

TEK ÇATAL 45°



KOD	ÇAP mm	MİKTAR ad.	FİYAT TL / m
2045	50-50	40	36,15
2051	70-50	20	40,78
2047	70-70	15	79,64
2052	110-50	8	84,91
2048	110-70	8	112,81
2054	110-110	4	141,60
2053	125-50	4	175,52
2049	125-70	4	189,01
2055	125-100	4	217,48
2057	125-125	4	265,91
2046	160-50	2	221,15
2050	160-70	2	240,50
2056	160-110	3	277,88
2058	160-125	3	318,65
2059	160-160	2	414,57

ÇİFT ÇATAL 45°



KOD	ÇAP mm	PAKET ad.	FİYAT TL / m
2075	50-50	30	43,22
2076	70-50	15	59,26
2077	70-70	10	93,24
2078	110-50	9	92,81
2079	110-70	6	141,77
2080	110-110	3	151,24
2081	125-50	5	149,92
2082	125-70	4	178,94
2083	125-100	3	218,70
2084	125-125	2	291,54
2085	160-50	2	337,44
2086	160-70	2	364,81
2087	160-110	2	353,92
2088	160-125	2	415,70
2089	160-160	1	579,54

TE ÇATAL 90°



KOD	ÇAP mm	PAKET ad.	FİYAT TL / m
2060	50-50	50	32,72
2061	70-50	20	49,67
2062	70-70	20	62,02
2063	110-50	12	74,39
2064	110-70	9	101,05
2065	110-110	8	106,58
2066	125-50	10	180,44
2067	125-70	8	192,13
2068	125-100	6	206,78
2069	125-125	6	239,64
2070	160-50	4	289,71
2071	160-70	4	319,69
2072	160-110	4	331,27
2073	160-125	3	371,45

REDÜKSİYON



KOD	ÇAP mm	MİKTAR ad.	FİYAT TL / m
2090	70-50	60	26,67
2091	110-50	25	40,06
2092	110-70	25	46,02
2093	125-70	15	67,60
2094	125-110	15	86,25
2095	160-110	12	142,86
2096	160-125	12	138,61

MANŞON



KOD	ÇAP mm	PAKET ad.	FİYAT TL / m
2127	50	60	25,07
2128	70	40	38,99
2129	110	15	72,65

KÖRTAPA



KOD	ÇAP mm	PAKET ad.	FİYAT TL / m
2108	50	500	8,45
2109	70	200	17,17
2110	110	75	31,93
2111	125	60	37,29

W SİFON



KOD	ÇAP mm	PAKET ad.	FİYAT TL / m
2122	110		287,50

S SİFON 87°



KOD	ÇAP mm	PAKET ad.	FİYAT TL / m
2101	110	4	196,97

S SİFON 45°



KOD	ÇAP mm	PAKET ad.	FİYAT TL / m
2125	110	4	209,06

DİZAYN TRIPLEX ATIK SU BORULARI - ÇOK SESSİZ

TRIPLEX ATIK SU BORULARI

KOD	ÇAP-BOY mm	ET mm	MİKTAR	FİYAT TL/ad.
5250	50 - 150	2,4	156	33,02
5251	50 - 250	2,4	104	39,77
5252	50 - 500	2,4	52	56,51
5253	50 - 1000	2,4	26	95,64
5254	50 - 2000	2,4	26	192,75
5255	50 - 3000	2,4	26	289,05
5256	50 - 6000	2,4	26	578,11
5257	70 - 150	2,6	102	48,84
5258	70 - 250	2,6	68	67,03
5259	70 - 500	2,6	34	92,63
5260	70 - 1000	2,6	17	158,06
5261	70 - 2000	2,6	17	296,60
5262	70 - 3000	2,6	17	461,39
5263	70 - 6000	2,6	17	922,77
5264	110 - 150	3,6	42	74,75
5265	110 - 250	3,6	28	95,45
5266	110 - 500	3,6	14	134,20
5267	110 - 1000	3,6	7	292,36
5268	110 - 2000	3,6	7	467,59
5269	110 - 3000	3,6	7	735,73
5270	110 - 6000	3,6	7	1.471,46
5271	125 - 150	3,7	42	90,29
5272	125 - 250	3,7	28	135,13
5273	125 - 500	3,7	14	197,00
5274	125 - 1000	3,7	7	343,44
5275	125 - 2000	3,7	7	705,29
5276	125 - 3000	3,7	7	1.039,17
5277	125 - 6000	3,7	7	2.078,34
5278	160 - 150	4,0	30	127,92
5279	160 - 250	4,0	20	195,42
5280	160 - 500	4,0	10	260,01
5281	160 - 1000	4,0	5	422,26
5282	160 - 2000	4,0	5	834,25
5283	160 - 3000	4,0	5	1.238,83
5284	160 - 6000	4,0	5	2.477,66

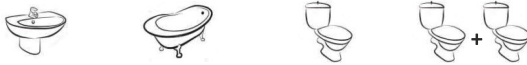

DEBİ	0,5	1	2	4
EN 14366	15	17	19	20
DIN 4109	16	18	20	22
VDI 4100	13	15	16	18

Sessizlik değerleri dB (A) cinsindedir.

Dizayn Triplex Çok Sessiz Atık Su Sistemi; boru, ek parça ve sessizlik kelepçesi ile bütündür. FRAUNHOFER Yapı Fiziyi Enstitüsü IBP tarafından P-BA 231/2017e numaralı raporuyla test düzeneği ile sırasıyla, saniyede 0,5 - 1 - 2 ve 4 litrelik akışlarla ölçülmüştür.

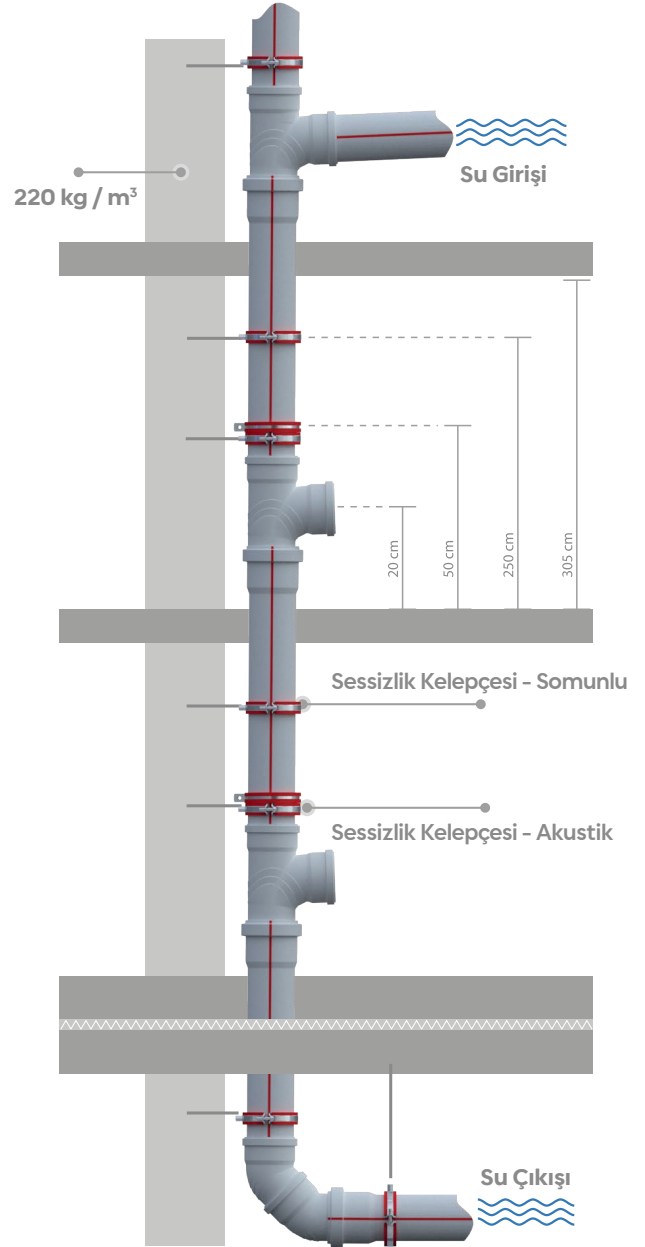

SOMUNLU KELEPÇE



KOD	ÇAP mm	PAKET ad.	FİYAT TL/ad.
50370	50		44,56
50371	75		65,67
50372	110		75,38
50373	125		98,92
50374	150		122,82

TRİFONLU KELEPÇE



KOD	ÇAP mm	PAKET ad.	FİYAT TL/ad.
50375	50		46,10
50376	75		68,25
50377	110		77,67
50378	125		101,45
50379	150		126,34

AKUSTİK SET

KOD	ÇAP mm	PAKET ad.	FİYAT TL/ad.
50380	50		43,62
50381	75		64,27
50382	110		72,14
50383	125		98,80
50384	160		119,94

DİZAYN TRIPLEX ATIK SU EK PARÇALARI - ÇOK SESSİZ

DİRSEK 45°



KOD	ÇAP mm	MİKTAR ad.	FİYAT TL / m
4035	50	100	19,35
4036	70	40	44,04
4037	110	10	76,84
4038	125	10	114,18
4044	160	5	228,27

DİRSEK 87°



KOD	ÇAP mm	PAKET ad.	FİYAT TL / m
4039	50	75	27,67
4040	70	30	44,26
4041	110	10	107,66
4042	125	8	179,32
4043	160	4	269,05

TEMİZLEME TE 90°



KOD	ÇAP mm	PAKET ad.	FİYAT TL / m
4097	70	20	313,83
4098	110	8	334,25
4099	125	6	432,67
4100	160	3	502,50

TEK ÇATAL 45°



KOD	ÇAP mm	MİKTAR ad.	FİYAT TL / m
4045	50-50	40	47,29
4051	70-50	20	59,78
4047	70-70	15	108,82
4052	110-50	8	134,82
4048	110-70	8	159,85
4054	110-110	4	230,44
4053	125-50	4	210,72
4049	125-70	4	242,19
4055	125-100	4	314,23
4057	125-125	4	370,26
4046	160-50	2	311,57
4050	160-70	2	334,81
4056	160-110	3	406,22
4058	160-125	3	461,93
4059	160-160	2	587,89

ÇİFT ÇATAL 45°



KOD	ÇAP mm	MİKTAR ad.	FİYAT TL / m
4075	50-50	30	84,34
4076	70-50	15	105,72
4077	70-70	10	145,98
4078	110-50	9	161,44
4079	110-70	6	219,72
4080	110-110	3	242,15
4081	125-50	5	215,98
4082	125-70	4	234,78
4083	125-100	3	387,14
4084	125-125	2	388,68
4085	160-50	2	474,28
4086	160-70	2	529,91
4087	160-110	2	597,82
4088	160-125	2	543,50
4089	160-160	1	1.986,68

TE ÇATAL 90°



KOD	ÇAP mm	PAKET ad.	FİYAT TL / m
4060	50-50	50	42,13
4061	70-50	20	143,94
4062	70-70	20	182,65
4063	110-50	12	182,72
4064	110-70	9	370,36
4065	110-110	8	148,38
4066	125-50	10	456,86
4067	125-70	8	408,60
4068	125-100	6	499,83
4069	125-125	6	553,08
4070	160-50	4	682,20
4071	160-70	4	765,74
4072	160-110	4	851,87
4073	160-125	3	1.186,84

REDÜKSİYON



KOD	ÇAP mm	MİKTAR ad.	FİYAT TL / m
4090	70-50	60	37,53
4091	110-50	25	53,00
4092	110-70	25	59,78
4093	125-70	15	99,61
4094	125-110	15	128,79
4095	160-110	12	175,01
4096	160-125	12	202,16

MANŞON



KOD	ÇAP mm	PAKET ad.	FİYAT TL / m
4127	50	60	32,63
4128	70	40	54,70
4129	110	15	86,96

KÖRTAPA



KOD	ÇAP mm	PAKET ad.	FİYAT TL / m
4108	50	500	11,93
4109	70	200	22,84
4110	110	75	40,77
4111	125	60	53,82

S SİFON 87°



KOD	ÇAP mm	PAKET ad.	FİYAT TL / m
4101	110	4	314,82

S SİFON 45°



KOD	ÇAP mm	PAKET ad.	FİYAT TL / m
4113	110	4	289,74

TRIPLEX ATIK SU BORULARI



KOD	ÇAP-BOY mm	ET mm	MİKTAR	FİYAT TL/ad.
6257	70 - 150	4,5	102	
6258	70 - 250	4,5	68	
6259	70 - 500	4,5	34	
6260	70 - 1000	4,5	17	
6261	70 - 2000	4,5	17	
6262	70 - 3000	4,5	17	
6264	110 - 150	5,3	12	
6265	110 - 250	5,3	8	
6266	110 - 500	5,3	14	
6267	110 - 1000	5,3	7	
6268	110 - 2000	5,3	3	
6269	110 - 3000	5,3	3	
6271	125 - 150	5,3	10	
6272	125 - 250	5,3	6	
6273	125 - 500	5,3	14	
6274	125 - 1000	5,3	7	
6275	125 - 2000	5,3	3	
6276	125 - 3000	5,3	3	
6278	160 - 150	5,3	6	
6279	160 - 250	5,3	4	
6280	160 - 500	5,3	10	
6281	160 - 1000	5,3	5	
6282	160 - 2000	5,3	3	
6283	160 - 3000	5,3	3	

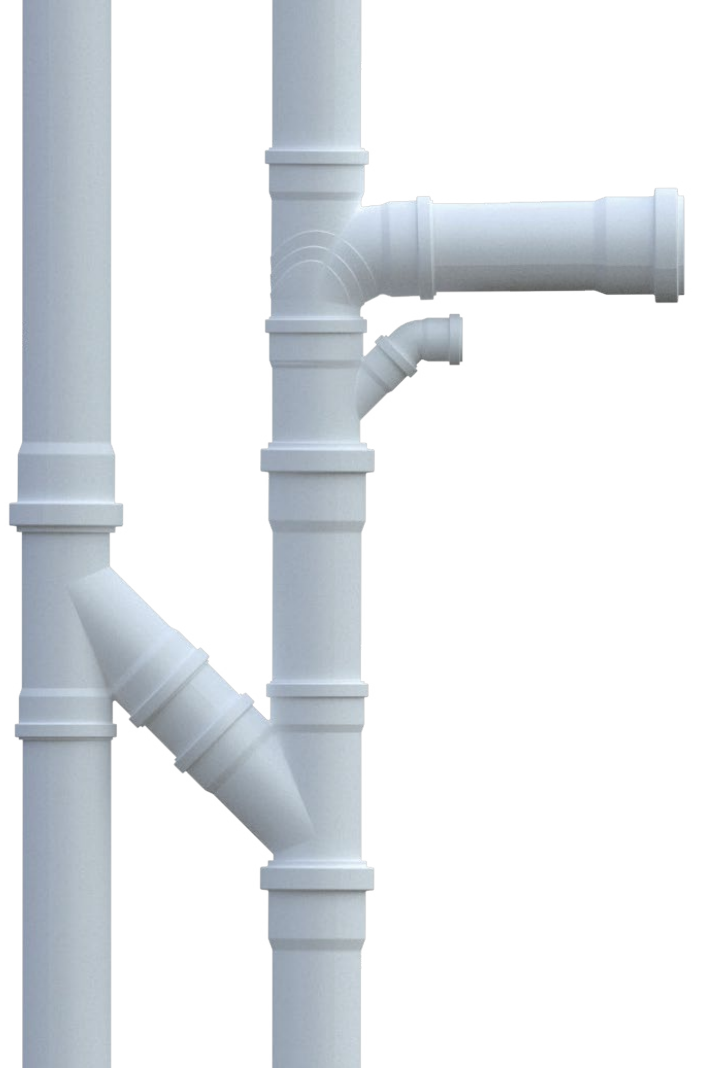

AKUSTİK KELEPÇE



KOD	ÇAP mm	PAKET ad.	FİYAT TL/ad.
50242	50	125	42,18
50243	70	40	69,31
50244	110	35	90,08
50245	125	25	106,37
50246	150	15	129,01

SOMUNLU KELEPÇE



KOD	ÇAP mm	PAKET ad.	FİYAT TL/ad.
50232	50	125	42,18
50233	70	40	69,31
50234	110	35	90,08
50235	125	25	106,37
50236	150	15	129,01

TRİFONLU KELEPÇE



KOD	ÇAP mm	PAKET ad.	FİYAT TL/ad.
50237	50	100	42,18
50238	70	50	69,31
50239	110	30	90,08
50240	125	20	106,37
50241	160	15	129,01

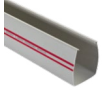

YAĞMUR OLUĞU

KOD	EBAT mm	PAKET ad.	FİYAT TL/ad.
45978	150x4000	5	888,95
45977*	150x4000	5	454,25

*ekonomik model



YAĞMUR OLUĞU İNİŞİ

KOD	EBAT mm	PAKET ad.	FİYAT TL/ad.
45983	150 - 70	12	105,80
45984	150 - 100	12	139,15



YAĞMUR OLUĞU DİRSEĞİ

KOD	EBAT mm	PAKET ad.	FİYAT TL/ad.
45981	150	12	109,25



YAĞMUR OLUĞU KÖRTAPASI

KOD	EBAT mm	PAKET ad.	FİYAT TL/ad.
45980	150	50	24,15



YAĞMUR OLUĞU MANŞONU

KOD	EBAT mm	PAKET ad.	FİYAT TL/ad.
45979	150	16	80,50



YAĞMUR OLUĞU KELEPÇESİ

KOD	EBAT mm	PAKET ad.	FİYAT TL/ad.
45982	150	100	36,80



SOFTPOWER PIPE

YUMUŞAK POLİETİLEN PN6

KOD	EBAT mm	PAKET m	FİYAT TL/ad.
48391	20	100	22,75
48392	25	100	32,34
48393	32	100	52,75
48394	40	10	84,38
48395	50	100	150,70
48396	63	100	221,51

YUMUŞAK POLİETİLEN PN10

KOD	EBAT mm	PAKET m	FİYAT TL/ad.
48353	20	100	38,00
48354	25	100	55,10
48355	32	100	85,40
48356	40	10	142,83
48357	50	100	218,05
48358	63	100	347,79

Neden Tercih Edilir?

- ✓ Dünyanın en güvenilir soft (yumuşak) polietilen hammadesinden imal edilir.
- ✓ Onlarca yıl ömürlüdür.
- ✓ Esnektir ve kolay şekil alır.
- ✓ Kaplin ile süper birleştirmeye uygundur.

Kullanım Alanları

- ✓ Park ve bahçe peyzaj sulama sistemlerinde,
- ✓ İçme suyu tesisatlarında,
- ✓ İçme suyu abone bağlantı hatlarında,
- ✓ Tarımsal sulama sistemleri,
- ✓ Sera sulama sistemleri.

PE-RT KILIFSIZ OKS. BARIYERSİZ



KOD	ÇAP-ET mm	PAKET ad.	FİYAT TL/ ad.
52020	16 x 2	160	19,05

PEX-B KILIFSIZ OKS. BARIYERSİZ



KOD	ÇAP-ET mm	PAKET ad.	FİYAT TL/ ad.
42	16 x 2	160	20,91

PEX ELESTİCA KILIFSIZ OKS. BARIYERSİZ



KOD	ÇAP-ET mm	PAKET ad.	FİYAT TL/ ad.
51040	16 x 2	160	21,07

PE-RT KILIFSIZ OKS. BARIYERLİ



KOD	ÇAP-ET mm	PAKET ad.	FİYAT TL/ ad.
52040	16 x 2	160	20,83

PEX-B KILIFSIZ OKS. BARIYERLİ



KOD	ÇAP-ET mm	PAKET ad.	FİYAT TL/ ad.
40017	16 x 2	160	23,99

PEX ELASTİCA KILIFSIZ OKS. BARIYERLİ



KOD	ÇAP-ET mm	PAKET ad.	FİYAT TL/ ad.
51045	16 x 2	160	24,23

PE-RT KILIFLI OKS. BARIYERSİZ



KOD	ÇAP-ET mm	PAKET ad.	FİYAT TL/ ad.
52032 L	16 x 2	100	23,67
52034B	16 x 2	100	23,67

PEX-B KILIFLI OKS. BARIYERSİZ



KOD	ÇAP-ET mm	PAKET ad.	FİYAT TL/ ad.
71 M	16 x 2	100	25,53
72 K	16 x 2	100	25,53

PEX ELASTİCA KILIFLI OKS. BARIYERSİZ



KOD	ÇAP-ET mm	PAKET ad.	FİYAT TL/ ad.
50901 M	16 x 2	100	25,69
50902 K	16 x 2	100	25,69

PE-RT KILIFLI OKS. BARIYERLİ



KOD	ÇAP-ET mm	PAKET ad.	FİYAT TL/ ad.
52060 L	16 x 2	100	25,45
52062B	16 x 2	100	25,45

PEX-B KILIFLI OKS. BARIYERLİ



KOD	ÇAP-ET mm	PAKET ad.	FİYAT TL/ ad.
45203 M	16 x 2	100	28,61
45204 K	16 x 2	100	28,61

PEX ELASTİCA KILIFLI OKS. BARIYERLİ



KOD	ÇAP-ET mm	PAKET ad.	FİYAT TL/ ad.
50903 M	16 x 2	100	28,85
50904 K	16 x 2	100	28,85

SİRAL KILIF BORUSU



KOD	ÇAP-ET mm	PAKET ad.	FİYAT TL/ ad.
110 M	25	100	7,48
112 K	25	100	7,48

PEX-A KILIFSIZ OKS. BARIYERLİ



KOD	ÇAP mm	PAKET m	FİYAT TL/ ad.
50340	16 x 2	600	

KÖŞE DÜZELTİCİ



KOD	ÇAP	PAKET ad.	FİYAT TL/ ad.
470		200	6,46

U KLİPS



KOD	ÇAP	PAKET ad.	FİYAT TL/ ad.
634	16	8000/500	0,63

CARBON BLACK KOLLEKTÖR



KOD	AĞIZ	PAKET ad.	FİYAT TL/ ad.
811	2	20	382,91
812	3	10	574,34
813	4	5	794,77
814	5	5	993,46
815	6	5	1.192,20
816	7	5	1.390,89
817	8	5	1.589,58
818	9	5	1.788,32
819	10	5	2.012,50
831	12	5	2.300,00

KILÇIK



KOD	ÇAP mm	PAKET ad.	FİYAT TL/ ad.
630	25	5000/250	0,69

KLİPSLİ LAMA 33 CM



KOD	ÇAP	PAKET ad.	FİYAT TL/ ad.
422	16	150	23,00

UZUN KILÇIK



KOD	ÇAP mm	PAKET ad.	FİYAT TL/ ad.
638	25	3000/200	2,07

DÜBELLİ YERE TESBİP KROŞESİ



KOD	ÇAP mm	PAKET ad.	FİYAT TL/ ad.
633	25	1000	3,06

KOLLEKTÖR KELEPÇESİ TAKIMI



KOD	ÇAP	PAKET ad.	FİYAT TL/ ad.
419		60	20,70

DÜBELSİZ YERE TESPİT KROŞESİ



KOD	ÇAP mm	PAKET ad.	FİYAT TL/ ad.
637	25	1000	2,45

DİZAYN MOBİL BORU SICAKLIK - KULLANIM ÖMRÜ - ÇALIŞMA BASINCI TABLOSU

Sıcaklık	Servis Ömrü	Maksimum Çalışma Basıncı (Bar)		
		°C	Yıl	PE X elasticA
10	1	21,94	21,37	20,22
	5	21,56	20,99	19,88
	10	21,40	20,83	19,73
	25	21,19	20,62	19,54
	50	21,04	20,46	19,40
20	1	19,50	18,93	18,59
	5	19,16	18,59	18,25
	10	19,01	18,44	18,10
	25	18,82	18,25	17,91
	50	18,68	18,11	17,77
30	1	17,51	16,80	16,94
	5	17,18	16,49	16,60
	10	17,03	16,36	16,46
	25	16,85	16,19	16,27
	50	16,71	16,06	16,13
40	1	15,28	14,95	15,28
	5	14,95	14,67	14,95
	10	14,81	14,55	14,81
	25	14,63	14,39	14,63
	50	14,49	14,27	14,49
50	1	14,19	13,33	13,62
	5	13,87	13,07	13,30
	10	13,74	12,96	13,17
	25	13,56	12,82	12,99
	50	13,43	12,71	12,85
60	1	12,54	11,91	11,97
	5	12,25	11,68	11,66
	10	12,15	11,58	11,53
	25	12,02	11,45	11,36
	50	11,92	11,35	11,23
70	1	11,24	10,67	10,34
	5	11,02	10,45	10,05
	10	10,93	10,36	9,93
	25	10,81	10,24	9,77
	50	10,72	10,15	9,65
80	1	10,14	9,57	8,76
	5	9,95	9,38	8,48
	10	9,86	9,29	8,37
	25	9,75	9,18	8,22
90	1	9,18	8,61	7,23
	5	9,00	8,43	6,98
	10	8,92	8,35	6,87
95	1	8,74	8,17	6,49
	5	8,56	7,99	6,26
	10	8,49	7,92	6,16

	PE-RT BORU	PEX-B BORU	PEX ELASTICA
Genel Özellikler			
Üretim Aralığı	16 - 110 mm	16 - 32 mm	16 20 mm
Renk	Turkuaz	Şeffaf	Kırmızı
Maksimum Sıcaklık	95°C	95°C	95°C
70 C Çalışma Basıncı	10	10	11
Mekanik Özellikler			
Kompozisyon	PE-RT çapraz bağ yok	%65 çapraz bağ	PEX-B - %65 çapraz bağ
Yüzey Pürüzsüzlüğü	0,007 mm/m	0,007 mm/m	0,007 mm/m
Dönüş Yarıçapı	5 x Dış çap	8 x Dış çap	5 x Dış çap
Su Taşıma Kapasitesi	16 x 2 - 0,113 l/m 20 x 2 - 0,201 l/m	16 x 2 - 0,113 l/m 20 x 2 - 0,201 l/m	16 x 2 - 0,113 l/m 20 x 2 - 0,201 l/m
Teknik Özellikler			
Isıl İletkenlik	0,40 W/m K	0,38 W/m K	0,38 W/m K
Isıl Uzama Katsayısı	0,18 mm/m K	0,14 mm/m K	0,14 mm/m K
Standartlar			
Üretim	EN 22391; SKZ H.R.3,16 (A.720)	DIN 16892; EN 15875; SKZ H.R.3,2 (A.721)	DIN 16892; EN 15875; SKZ H.R.3,2 (A.721)
Oksijen Bariyer	DIN 4726	DIN 4726	DIN 4726
Yoğunluk 23°C (kg/m³)	0,935 - 0,942	947 - 950	0,940 - 0945
Gerilme Direnci 23°C (N/mm²)	0,935 - 0,942	947 - 950	0,940 - 0945
100°C	N / A	-12	9,2 - 13
Elastisite Modülü 23°C (N/mm²)	-640	-750	-950
100°C	N / A	N / A	560
Kopma Uzaması 23°C (N/mm²)	>800	>300	>400
100°C	N / A	N / A	>550
Çapraz Bağlanma Derecesi (%)	N / A	65	65

Hangisini Seçmeliyim?

Mobil boruların kullanılacağı tesisatın basınç, sıcaklık ve dayanım gerekliliklerine göre Dizayn Mobil Borular içinden uygun olanı seçmek sizden, tüm tesisatlarda güvenle kullanabileceğiniz mobil borular Dizayn Grup'tan...

Kullanım Alanları

- Yüzey Isıtma Sistemleri
- Yüksek / Düşük sıcaklıklı radyatör sistemleri
- Yerden, tavandan, duvardan ısıtma / serinletme sistemleri
- İçme suyu sistemleri
- Güneş enerjisi, soğutma ve havalandırma sistemleri

ELITE PIPE

"Güvenin ve Rahatlığın Keyfini Yaşa"

SIHHİ TESİSATTA DEVRİM

2 günlük tesisatı 1 günde bitireceksiniz

Kırılma ve Çatlamaya Son

Zaman Kaybına Son

Manşona Son

Dirseğe Son

Kavise Son

Fireye Son

USTA DOSTU



Önemli Bilgilendirme



- ELITE PIPE sistem garantisi; sadece **ELITE PIPE** boru, **ELITE PIPE** ek parçalar ve özel kaynak paftası ile birlikte kaynak yapılırsa geçerlidir.
- PPR borudan, ELITE PIPE borulara geçiş için, '**ELITE PIPE PPRC BORU GEÇİŞ PARÇASI**' kullanılmalıdır.
- ELITE PIPE ürünleri; herhangi bir PPR boru, ppr ek parça veya ppr pafta ile birlikte kullanılmışsa sistem garanti edilmez. Bu durumda sadece **ELITE PIPE** boru ve ek parçamız bağımsız olarak garanti edilir.

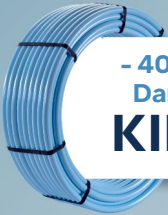

- 40°C Soğuktaki
Darbelerde dahi
KIRILMAZ



Taşıma ve sevkiyatlar
Kangal boruyla çok
KOLAY



Yüksek sıcaklıkta
Yüksek basınca
DAYANIKLI



Kangal özelliği
Sayesinde
FİRESİZ



Hızlı işçilik ile
Zamandan
TASARRUF



Daha az ek parça
Sayesinde Ekonomik
EKONOMİK



Kimyasallara karşı
Yüksek dayanımıyla
DİRENÇLİ



Tanıtım filmi
için okutunuz



Teknik katalog
için okutunuz



Kolay, hızlı ve bilindik
Kaynak yöntemiyle
USTA DOSTU

ELITE PIPE TESİSAT BORULARI

ELITE PIPE BORU PN25



KOD	ÇAP mm	MİKTAR m	FİYAT TL/m
30482	20	160	26,67
30484	25	120	42,68
30486	32	80	76,80
30588	40	60	118,16
30590	50	36	189,24
30592	63	24	303,89

ELITE PIPE KANGAL BORU PN25



KOD	ÇAP mm	MİKTAR m	FİYAT TL/m
30582	20	60	28,00
30584	25	48	44,81
30586	32	24	80,64

ELITE PIPE KOMPOZİT BORU PN25



KOD	ÇAP mm	MİKTAR m	FİYAT TL/m
33066	20	160	32,55
33068	25	120	47,96
33070	32	80	85,59
33072	40	60	127,82
33074	50	36	204,62
33076	63	24	326,94

ELITE PIPE OKSİ PLUS KOMBİ BORU PN32



KOD	ÇAP mm	MİKTAR m	FİYAT TL/m
27110	20	160	42,75
27112	25	120	58,09
27114	32	80	103,30
27116	40	60	158,03
27118	50	36	246,62
27120	63	24	395,61

ELITE PIPE FEDERLİ BORU PN25



KOD	ÇAP mm	MİKTAR m	FİYAT TL/m
33322	20	160	28,27
33324	25	120	45,24
33326	32	80	81,40
33328	40	60	125,25
33330	50	36	200,60
33332	63	24	322,12

ELITE PIPE FEDERLİ KANGAL BORU PN 25



KOD	ÇAP mm	MİKTAR m	FİYAT TL/m
33334	20	60	29,68
33336	25	48	47,50
33338	32	24	85,47

ELITE PIPE GÜNEŞ KOLEKTÖRÜ BORUSU FOLYOLU UV DAYANIMLI



KOD	ÇAP mm	MİKTAR m	FİYAT TL/m
27090	20		44,88
27092	25		61,00
27094	32		108,46

ELITE PIPE GÜNEŞ KOLEKTÖRÜ BORUSU UV DAYANIMLI

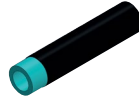

KOD	ÇAP mm	MİKTAR m	FİYAT TL/m
27100	20		33,60
27102	25		49,93
27104	32		84,48

NİPEL İÇ DİŞLİ



KOD	ÇAP mm	MİKTAR ad.	FİYAT TL/ad.
34230	20 1/2"	250	32,74
34232	20 3/4"	175	39,84
34234	25 3/4"	150	39,84
34236	25 1/2"	200	31,02
34238	32 1"	75	70,08

NİPEL DİŞ DİŞLİ



KOD	ÇAP mm	MİKTAR ad.	FİYAT TL/ad.
34452	20 1/2"	200	34,47
34454	20 3/4"	150	50,00
34456	25 3/4"	150	48,83
34458	25 1/2"	175	34,68
34460	32 1"	80	84,70

TAHARET BATARYA BAĞ.



KOD	ÇAP mm	MİKTAR ad.	FİYAT TL/ad.
36106	20 1/2"	28	91,94

ALTI KÖŞE NİPEL İÇ DİŞLİ



KOD	ÇAP mm	MİKTAR ad.	FİYAT TL/ad.
34222	32 1"	75	77,37
34224	40 1 1/4"	40	149,49
34226	50 1 1/2"	30	188,03
34228	63 2"	18	381,57

ALTI KÖŞE NİPEL DİŞ DİŞLİ



KOD	ÇAP mm	MİKTAR ad.	FİYAT TL/ad.
34462	32 1"	60	110,26
34464	40 1 1/4"	40	191,35
34466	50 1 1/2"	20	248,19
34468	63 2"	20	378,33

RAKORLU DİRSEK



KOD	ÇAP mm	MİKTAR ad.	FİYAT TL/ad.
34476	20 1/2"	125	94,74
34478	25 3/4"	125	113,56

O.B. ALTI KÖŞE RAKOR İÇ DİŞLİ



KOD	ÇAP mm	MİKTAR ad.	FİYAT TL/ad.
31320	20 1/2"	200	62,70
31322	25 3/4"	150	99,46
31324	20 1"	100	140,08
31326	25 1"	100	153,16
31328	32 1"	100	121,15
31330	40 1 1/4"	50	214,05
31332	50 1 1/2"	40	386,62

O.B. ALTI KÖŞE RAKOR DİŞ DİŞLİ



KOD	ÇAP mm	MİKTAR ad.	FİYAT TL/ad.
31546	20 1/2"	200	65,58
31548	25 3/4"	150	97,24
31550	20 1"	100	139,60
31552	25 1"	100	142,60
31554	32 1"	100	128,24
31556	40 1 1/4"	50	231,07
31558	50 1 1/2"	40	407,98

RAKORLU NİPEL



KOD	ÇAP mm	MİKTAR ad.	FİYAT TL/ad.
34472	20 1/2"	125	138,00
34474	25 3/4"	125	152,95

DİRSEK İÇ DİŞLİ



KOD	ÇAP mm	MİKTAR ad.	FİYAT TL/ad.
34630	20 1/2"	200	33,27
34632	20 3/4"	150	41,15
34634	25 1/2"	100	37,82
34636	25 3/4"	100	42,20
34638	32 3/4"	100	55,66
34640	32 1"	50	78,55

DİRSEK DİŞ DİŞLİ



KOD	ÇAP mm	MİKTAR ad.	FİYAT TL/ad.
34642	20 1/2"	125	37,70
34644	20 3/4"	100	49,87
34646	25 1/2"	125	42,44
34648	25 3/4"	90	49,87
34650	32 3/4"	75	64,30
34652	32 1"	50	91,87

PİSLİK TUTUCU



KOD	ÇAP mm	MİKTAR ad.	FİYAT TL/ad.
34480	20 1/2"	125	97,26
34482	25 3/4"	125	111,60

TE İÇ DİŞLİ



KOD	ÇAP mm	MİKTAR ad.	FİYAT TL/ad.
34720	20 1/2"	150	34,24
34722	20 3/4"	100	44,69
34724	25 1/2"	100	39,45
34726	25 3/4"	100	45,49
34728	32 3/4"	60	72,69
34730	32 1"	50	83,58

TE DİŞ DİŞLİ



KOD	ÇAP mm	MİKTAR ad.	FİYAT TL/ad.
36734	20 1/2"	125	39,19

İKİ TARAFI KAYNAKLI RAKOR



KOD	ÇAP mm	MİKTAR ad.	FİYAT TL/ad.
31534	20	150	118,97
31536	25	100	160,66
31538	32	80	183,11
31540	40	50	343,70
31542	50	30	398,41

TEKLİ BATARYA BAĞLANTISI



KOD	ÇAP mm	MİKTAR ad.	FİYAT TL/ad.
36110	20 1/2"	125	37,04
36112	25 1/2"	90	47,84

ÇİFTLİ BATARYA BAĞLANTISI



KOD	ÇAP mm	MİKTAR ad.	FİYAT TL/ad.
31120	20 1/2"	24	90,29
31122	25 1/2"	24	116,93

ÇEK VALF



KOD	ÇAP mm	MİKTAR ad.	FİYAT TL/ad.
34484	20	75	117,28
34486	25	50	134,46

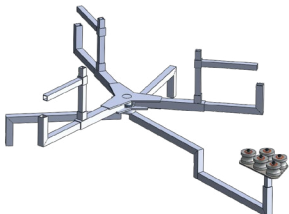

ELITE KANGAL AÇMA MAKARASI

KOD	FİYAT TL/ad.
48373	20.578,95

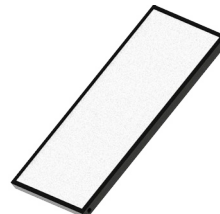

TERMAL GÜNEŞ KOLEKTÖRÜ

KOD	FİYAT TL/ad.
65372	Beton Kasa 16.324,25

ELITE PIPE EK PARÇALARI



PPRC BORU GEÇİŞ PARÇASI

KOD	ÇAP mm	MİKTAR ad.	FİYAT TL/ad.
33449	20	200	5,72
33451	25	150	9,61
33453	32	80	20,56



TE

KOD	ÇAP mm	MİKTAR ad.	FİYAT TL/ad.
33820	20	200	4,61
33822	25	100	6,65
33824	32	50	13,52
33826	40	30	28,52
33828	50	15	48,75
33830	63	9	109,98



TE KAVİŞ

KOD	ÇAP mm	MİKTAR ad.	FİYAT TL/ad.
33816	20	75	29,08
33818	25	40	40,79

MANŞON



KOD	ÇAP mm	MİKTAR ad.	FİYAT TL/ad.
33438	20	400	2,57
33440	25	200	3,78
33442	32	150	7,38
33444	40	60	12,39
34446	50	45	23,85
34448	63	24	41,48



İNEGAL TE

KOD	ÇAP mm	MİKTAR ad.	FİYAT TL/ad.
33832	25-20-20	150	8,29
33834	25-20-25	150	8,61
33836	32-20-20	125	13,72
33840	32-20-32	75	14,98
33842	32-25-20	75	14,38
33844	32-25-32	50	17,92
33848	40-25-40	30	29,40
33850	40-32-40	30	31,29
33854	50-25-50	15	58,86
33856	50-32-50	15	62,22
33858	50-40-50	15	71,95
33864	63-32-63	9	94,52
33866	63-40-63	9	98,69
33868	63-50-63	9	101,76



MANŞONLU KAVİŞ

KOD	ÇAP mm	MİKTAR ad.	FİYAT TL/ad.
34114	20	75	20,92
34116	25	40	29,01

DİRSEK 90°



KOD	ÇAP mm	MİKTAR ad.	FİYAT TL/ad.
33648	20	250	3,33
33650	25	150	5,06
33652	32	75	10,28
33654	40	40	20,57
33656	50	20	38,78
33658	63	12	77,69

DİRSEK 45°



KOD	ÇAP mm	MİKTAR ad.	FİYAT TL/ad.
33660	20	300	4,87
33662	25	200	5,96
33664	32	75	12,28

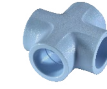

İSTAVROZ

KOD	ÇAP mm	MİKTAR ad.	FİYAT TL/ad.
34018	20	60	11,48
34020	25	50	16,23
34022	32	25	27,73

REDÜKSİYON



KOD	ÇAP mm	MİKTAR ad.	FİYAT TL/ad.
33534	25-20	400	2,92
33536	32-20	300	4,50
33538	32-25	200	5,16
33542	40-25	150	8,79
33544	40-32	100	10,41
33546	50-20	125	13,43
33548	50-25	120	14,13
33550	50-32	100	15,19
33552	50-40	60	19,18
33554	63-25	50	23,69
33556	63-32	40	28,22
33558	63-40	50	30,10
33560	63-50	30	35,42



KAYNAK MAKİNESİ SET

KOD	ÇAP mm	MİKTAR ad.	FİYAT TL/ad.
43168	20-40	1	3.439,76

KAYNAK MAKİNESİ TEKLİ



KOD	ÇAP mm	MİKTAR ad.	FİYAT TL/ad.
43166	20-40	6	2.327,12

ÖZEL KAYNAK PAFTASI



KOD	ÇAP mm	MİKTAR ad.	FİYAT TL/ad.
46637	20	50	191,23
46638	25	50	208,76
46639	32	25	242,41
46640	40	20	268,61
46641	50	10	407,71
46642	63	5	574,92
46643	16	50	74,56
46644	20	50	87,72

KAPAMA BAŞLIĞI



KOD	ÇAPmm	MİKTAR ad.	FİYAT TL/ad.
33872	20	400	3,43
33874	25	300	4,43
33876	32	200	8,14
33878	40	150	13,40
33880	50	100	21,28
33882	63	125	43,06



BORU İÇİ KAYNAK MALAFA

KOD	ÇAP mm	MİKTAR ad.	FİYAT TL/ad.
46614	16-20	1	2.248,25



DÜZ KAVİŞ

KOD	ÇAP mm	MİKTAR ad.	FİYAT TL/ad.
30922	20	25	22,38
30924	25	20	32,18
30926	32	12	54,53



OMEGA

KOD	ÇAP mm	MİKTAR ad.	FİYAT TL/ad.
30934	20	20	139,27
30936	25	12	202,82
30938	32	10	235,33



KÜRESAL VANA

KOD	ÇAP mm	MİKTAR ad.	FİYAT TL/ad.
34870	20	60	141,78
34872	25	50	169,44
34874	32	25	258,20
34876	40	20	345,87



KÜRESAL VANA

KOD	ÇAP mm	MİKTAR ad.	FİYAT TL/ad.
34878	20	60	138,54
34880	25	50	164,70
34882	32	25	253,35
34884	40	20	331,60



KELEBEK BAŞLI VANA

KOD	ÇAP mm	MİKTAR ad.	FİYAT TL/ad.
34854	20	50	142,21
34856	25	40	152,10



KROMLU VANA UZUN

KOD	ÇAP mm	MİKTAR ad.	FİYAT TL/ad.
34862	20	25	317,64
34868	25	30	346,07



KROMLU VANA

KOD	ÇAP mm	MİKTAR ad.	FİYAT TL/ad.
34860	20	30	256,65
34864	25	20	282,43



BORU İÇİ KAYNAK ADAPTÖRÜ

KOD	ÇAP mm	MİKTAR ad.	FİYAT TL/ad.
33456	16	500	1,59
33458	20	400	1,71

yeni
 ürün

Dizayn Gömme Rezervuar

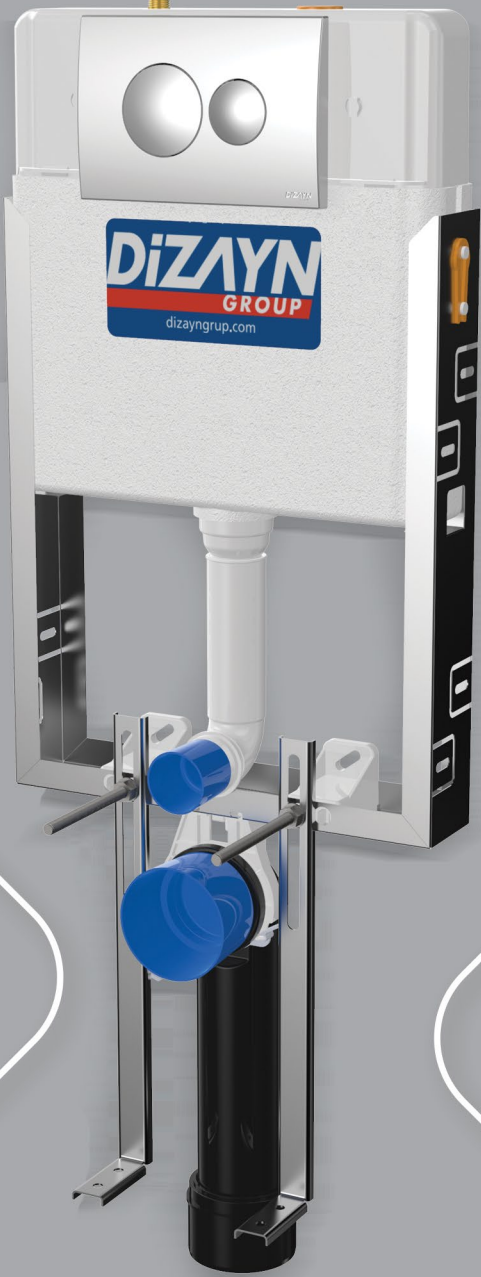

Alafranga
gömme
rezervuar



Alaturka
gömme
rezervuar

GÖMME REZERVUAR ALAFRANGA

KOD	ÇAP	PAKET ad.	FİYAT TL/ ad.
48367	L900		3.673,08

GÖMME REZERVUAR ALATURCA

KOD	ÇAP	PAKET ad.	FİYAT TL/ ad.
48374	L900		2.999,68

 dizayngrup.com

   • [dizayngrup](https://www.dizayngrup.com)

DIZAYN
GRUP

İletişim

FABRİKA

5.Ada 4. Parsel Hacı Şeremet Mevki
Veli Meşe Kazan Sanayicileri
Toplu İş Yeri Koop. Ergene / Tekirdağ
0282 676 46 40
info@dizayngrup.com

MERKEZ

Dizayn Teknik Boru ve Elemanları
San. ve Tic. A.Ş.
Atatürk Mah. Adnan Menderes Cad.
No:6 Esenyurt / İstanbul
Tel: 0212 886 57 41
info@dizayngrup.com



	Marmara Bölgesi	0549 842 78 28
	Ege Bölgesi	0549 538 85 31
	Akdeniz Bölgesi	0549 538 85 31
	İç Anadolu Bölgesi	0542 467 01 24
	Karadeniz Bölgesi	0549 842 78 26
	Güneydoğu Bölgesi	0549 842 78 31
	Doğu Anadolu Bölgesi	0543 493 42 15
	AltYapı Satış Direktörü	0542 225 44 13

BÜTÇE DOSTU

Premix Tam Yoğuşmalı Kombiler

DIZAYN | KOMBİ

doru



65 cm

kW
24/28/35

A⁺ Enerji Sınıfı



Kombitech PLUS



kW
24/28



Kombi web sitemizi
ziyaret etmek için QR Kodu okutunuz

dizayngrup.com

[in](#) [f](#) [t](#) [i](#) /dizayngrup

Dizayn Teknik Boru ve Elemanları San. ve Tic. A.Ş.

Atatürk Mah. Adnan Menderes Cad.

No:6 34522 Esenyurt, İstanbul / Türkiye

Tel : +90 (212) 886 57 41 Fax : +90 (212) 886 51 93

www.dizayngrup.com

info@dizayngrup.com